

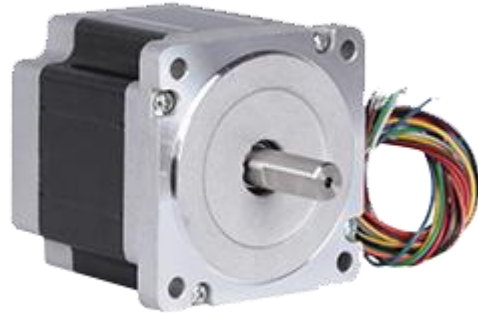

GMTCNT STEPPER MOTORS
MODEL: GSTM8618-080-842
User Guide



Attention !

Read the user manual carefully before using the device!

Responsibility for damages, losses and personal accidents caused by not following the warnings in the user manual belongs to the user. In case of failure to comply with the instructions, the product will be out of warranty.

GMTCNT

GMT ENDÜSTRİYEL ELEKTRONİK SAN. VE TİC. LTD. ŞTİ.

Çubuklu Mahallesi Boğaziçi Caddesi No:6/B 34805 Beykoz / İstanbul / Türkiye

T +90 (216) 668 00 06

Web site: <http://www.gmtcontrol.com/>

F +90 (216) 668 00 03

E-Mail: gmt@gmtcontrol.com

1. Technical Specifications

Model	L(mm)	N.m	A	Shaft Diameter (mm)
GSTM8618-080-842	80	4.5	4.2	12.7

2. Mechanical Drawing (mm)

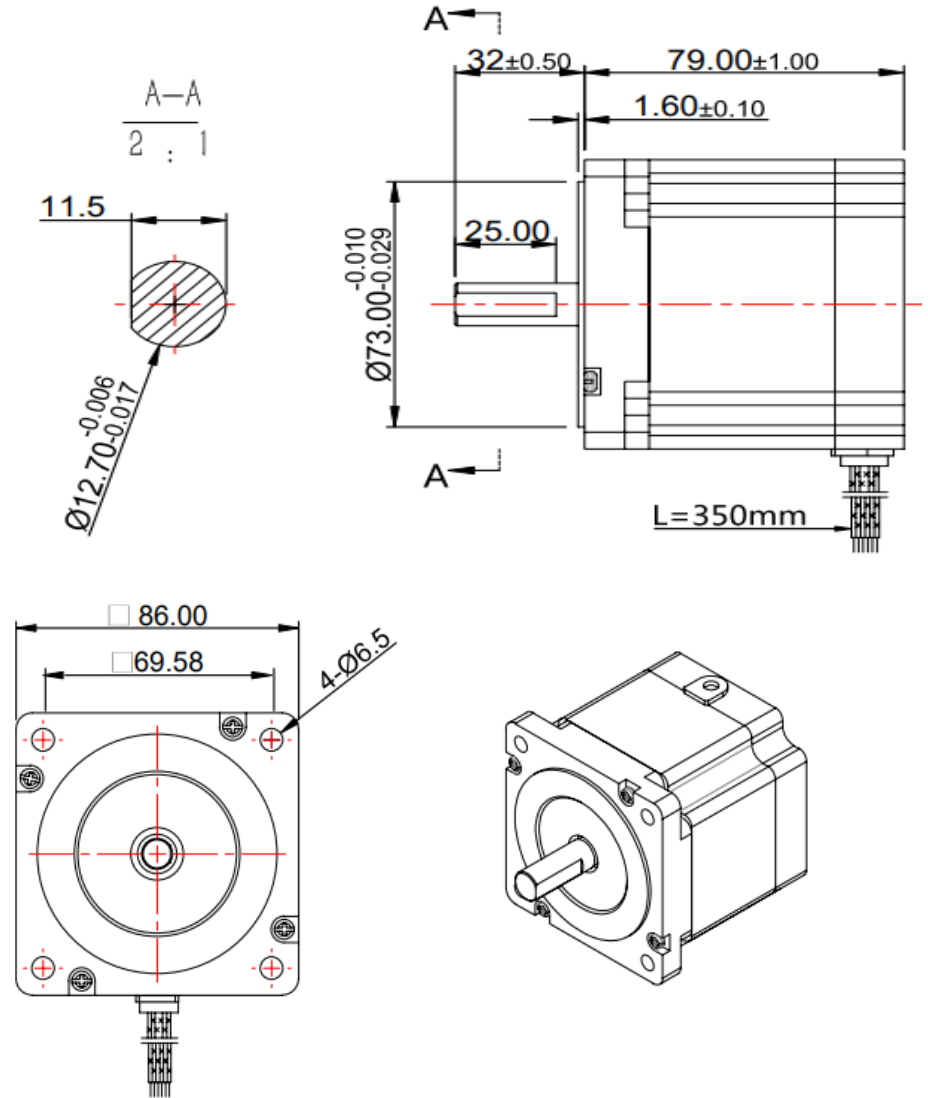

3. Connection Diagram

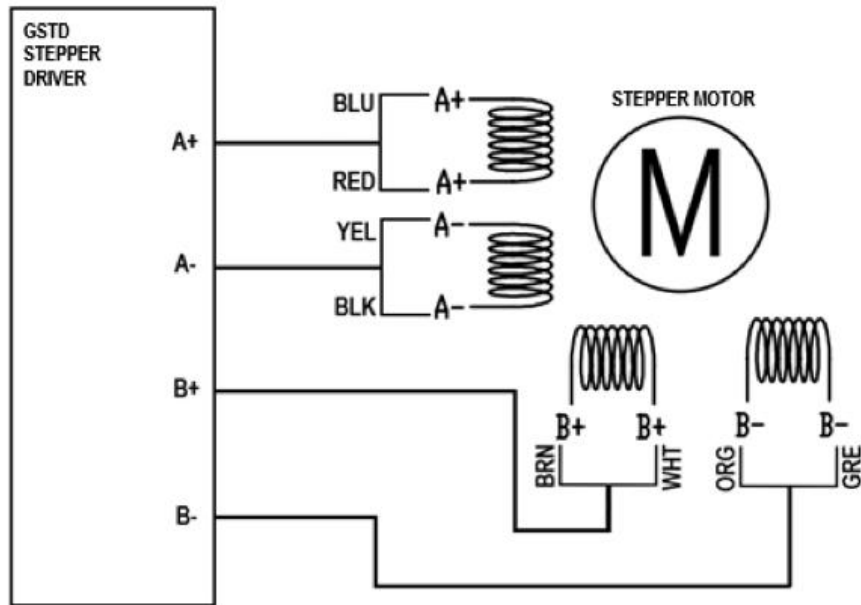

4. Stepper Motor Torque-Speed Curves

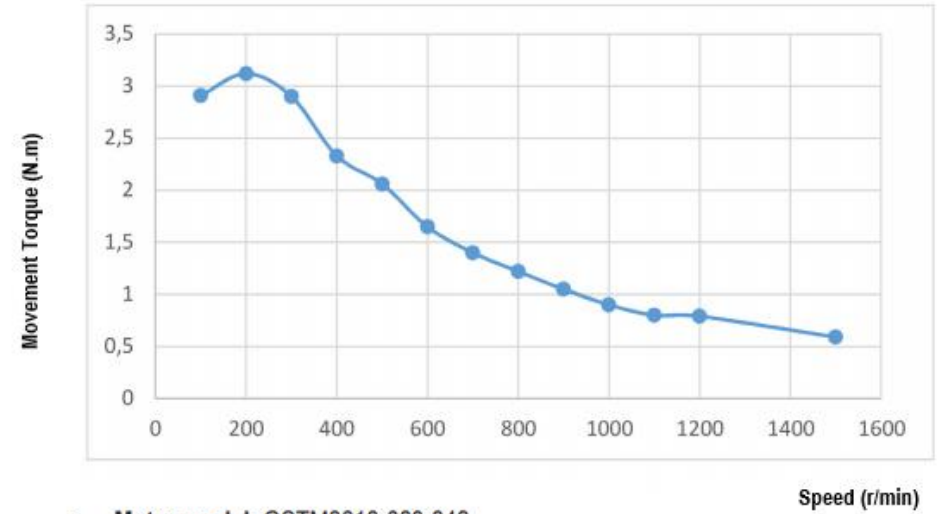

- **Motor model:** GSTM8618-080-842
- **Test voltage:** 80 VDC
- **Motor:** Parallel connection
- **Test driver:** GSTD2860
- **Test microstep:** 8 (1600 PPR)
- **Test current:** 4.0 A (RMS)